

© COPYRIGHT 1978 BY AMP INCORPORATED, HARRISBURG, PA.
 ALL INTERNATIONAL RIGHTS RESERVED. AMP INCORPORATED PRODUCTS
 COVERED BY U. S. AND FOREIGN PATENTS AND/OR PATENTS PENDING.

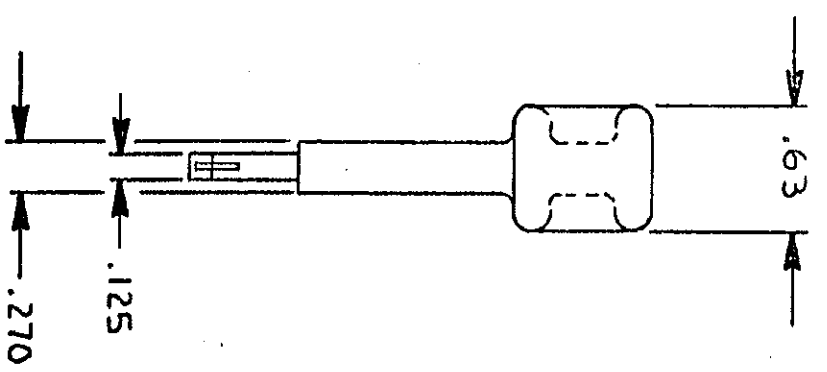
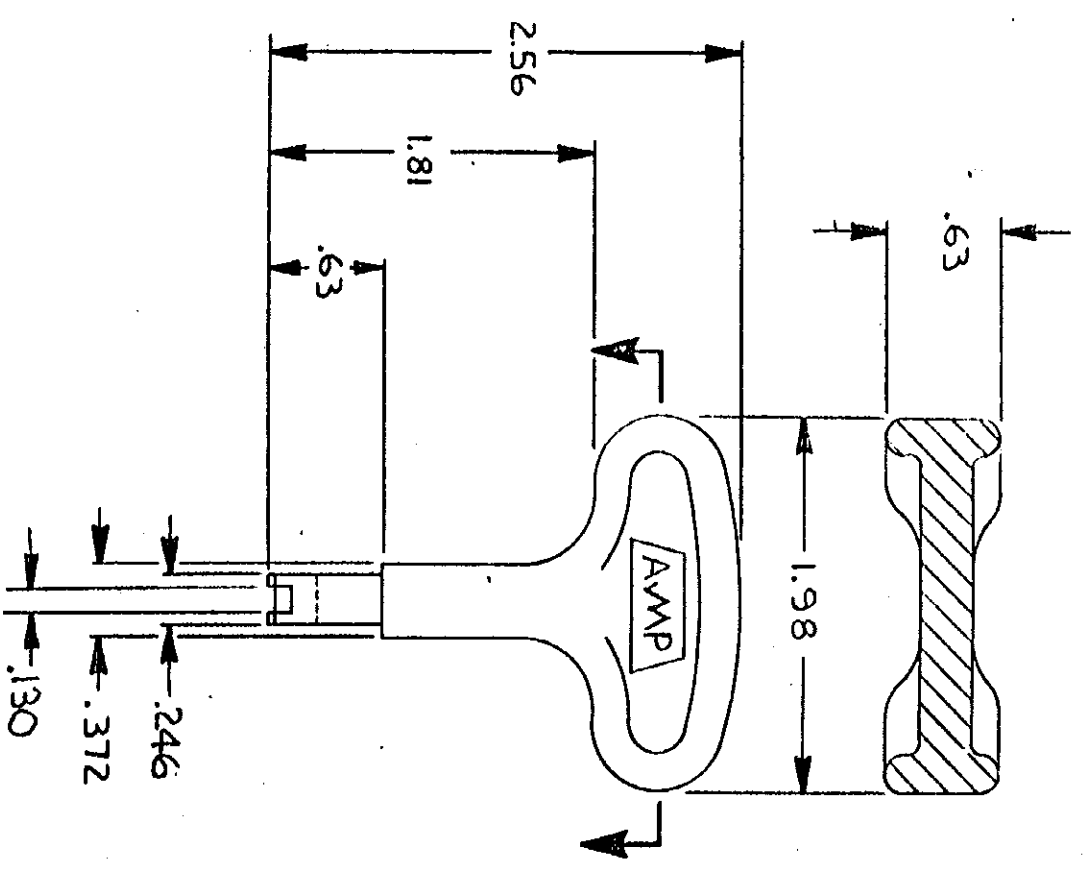

1. ALL DIM. SHOWN ARE FOR REF ONLY.

229384-1 AS SHOWN

REVOLUTIONS		REVISIONS		LOC	DATE	DIST
P	F	ZONE	LTR	DESCRIPTION	DATE	APPROVED
0	✓		0	ASFD	6-13-78	RS

UNLESS OTHERWISE SPECIFIED DIMENSIONS ARE IN INCHES. DECIMALS IN ANGLES ± .01		CONTRACT NO		NAME	
MATERIAL BLACK NYLON		DR <i>Randy Orvino</i> 6-13-78		AMP INCORPORATED Harrisburg, Pa.	
FINISH //		CHK <i>PK</i> 6-14-78		TOOL, INSERTION, HAND	
OTHER APPD		APPD		SIZE B	
		DSGN APPD		CODE IDENT NO 00779	
		OTHER APPD		DRAWING NO 229384	
				SCALE 1/1	
				SHEET 1 OF 1	

CUSTOMER DRAWING